

Installation Guide

220-240V / 50-60Hz
IP20 IK03



Terminal Labelling:

Power

L1 Switched Live
E Earth
N Neutral

Emergency

L2 Unswitched Live
DA/AT3 DALI Autotest
DALI Autotest

Dimming

-/D1/DA Analogue/DSI/DALI
+/D2/DA Analogue/DSI/DALI
L3 Switch Dim / Corridor Function

WARNING: Luminaire must be earthed. Risk of electric shock from LED boards if operated with cover removed. Installation / operation outside of luminaires intended scope invalidates warranty. Suitable only for domestic / light industrial / industrial applications within the scope of EN55015. Tested to compliance with BSEN 60598: specification for general requirements and tests. Must be installed by a suitably qualified person in accordance with all relevant legislation. Ambient operating temperature of 0°C to 25°C. If maximum operating temperature is exceeded luminaire will automatically dim / switch off. Terminal blocks are rated to 16A unless stated otherwise. The light source contained in this luminaire shall only be replaced by the manufacturer or his service agent or a similar qualified person. **LUMINAIRES WITH EMERGENCY PACK:** When supply is isolated battery output terminals may be live if battery is connected. Isolate mains and battery before servicing. Emergency luminaires require unswitched live connection taken from same phase as switched supply. When unswitched supply is connected status indicator illuminates green, when unswitched supply is disconnected indicator extinguishes and luminaire operates in emergency mode. 24 hour charge period required before undertaking full discharge test. Emergency test sheets provided should be used to record all emergency tests. Batteries should be replaced when 3 hour duration is not met. Excessive switching of permanent live may result in premature battery failure. Battery electrolyte can be harmful to eyes / open wounds, do not puncture, if electrolyte touches skin / eyes flush with water. Do not incinerate batteries.

1

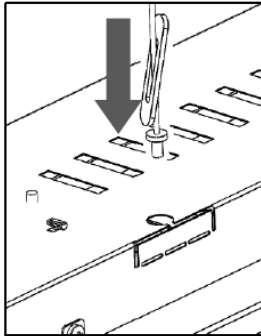

Insert toggle to suspend

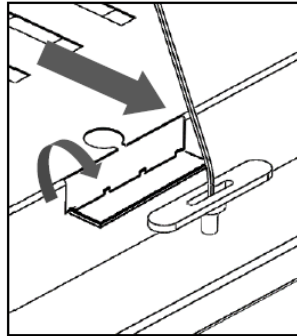

Bend the tab to release

2

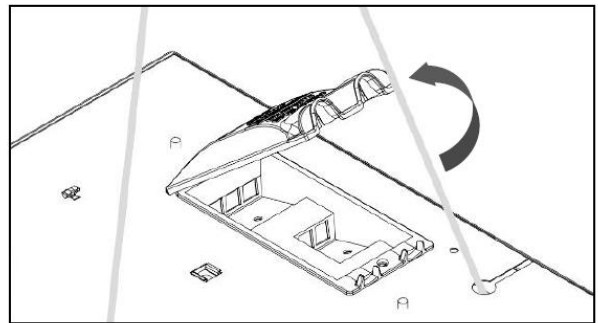

Unscrew and open the back flap to gain access to the terminal blocks.

3

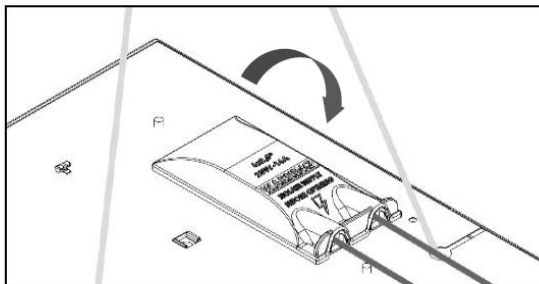

Connect the wires to the terminal blocks, then close and refasten the back-flap to secure them.

4

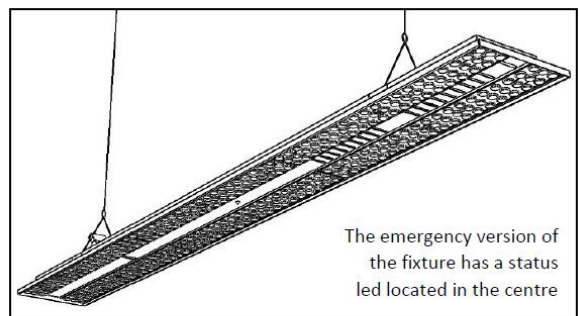

Check that the fitting is level before powering it on for operation.

Maintenance:

1. Disconnect the luminaire before undertaking any maintenance or cleaning.
2. Clean only the external parts of the luminaire with a slightly damp, lint-free cloth.
3. Using a pan pozi screwdriver, you can detach the led circuit from underneath the tray, allowing access to the fitting and removal of the components.
4. If you require spare components, please contact us for assistance.

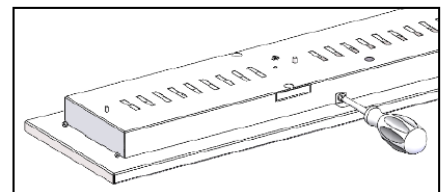

Led Circuit

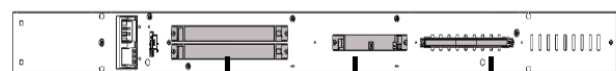
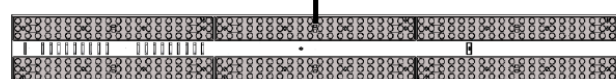

Driver

Module

Battery