

220-240V / 50-60Hz

IP65

IK09



WARNING: Luminaire must be earthed. Risk of electric shock from LED boards if operated with cover removed. Installation / operation outside of luminaires intended scope invalidates warranty. Suitable only for domestic / light industrial / industrial applications within the scope of EN55015. Tested to compliance with BSEN 60598: specification for general requirements and tests. Must be installed by a suitably qualified person in accordance with all relevant legislation. Ambient operating temperature of 0°C to 25°C. If maximum operating temperature is exceeded luminaire will automatically dim / switch off. Terminal blocks are rated to 16A unless stated otherwise. The light source contained in this luminaire shall only be replaced by the manufacturer or his service agent or a similar qualified person. **LUMINAIRES WITH EMERGENCY PACK:** When supply is isolated battery output terminals may be live if battery is connected. Isolate mains and battery before servicing. Emergency luminaires require unswitched live connection taken from same phase as switched supply. When unswitched supply is connected status indicator illuminates green, when unswitched supply is disconnected indicator extinguishes and luminaire operates in emergency mode. 24 hour charge period required before undertaking full discharge test. Emergency test sheets provided should be used to record all emergency tests. Batteries should be replaced when 3 hour duration is not met. Excessive switching of permanent live may result in premature battery failure. Battery electrolyte can be harmful to eyes / open wounds, do not puncture, if electrolyte touches skin / eyes flush with water. Do not incinerate batteries.

Terminal Labelling:

Power	
L1	Switched Live
E	Earth
N	Neutral
Emergency	
L2	Unswitched Live
DA/AT3	DALI Autotest
DA/AT3	DALI Autotest
Dimming	
-/D1/DA	Analogue/DSI/DALI
+/D2/DA	Analogue/DSI/DALI
L3	Switch Dim / Corridor Function

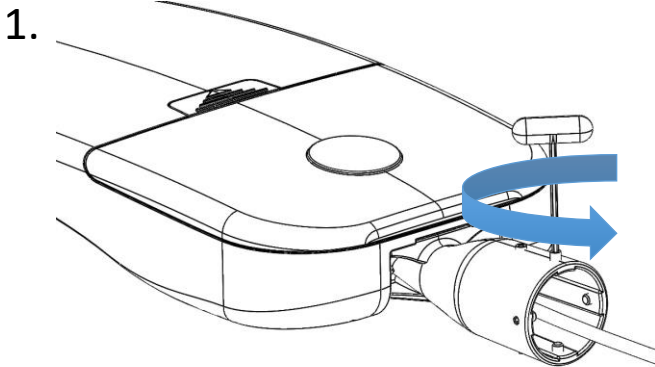

1. Using a 4mm Allen Key, loosen all the grub screws sufficiently to allow for the column diameter.

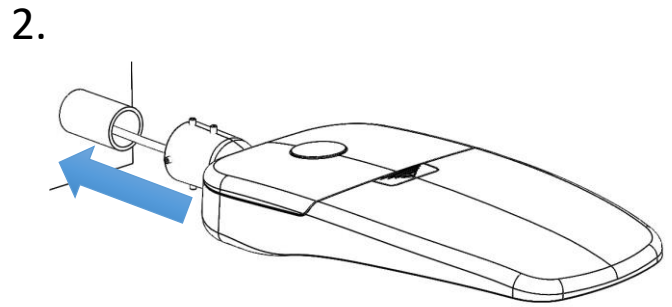

2. Feed the mains cable into the column and offer the spigot up to the column.

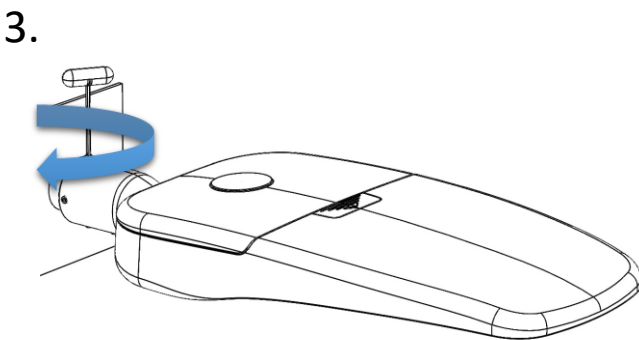

3. Using the 4mm Allen Key, tighten all the grub screws slightly so the fitting can still rotate.

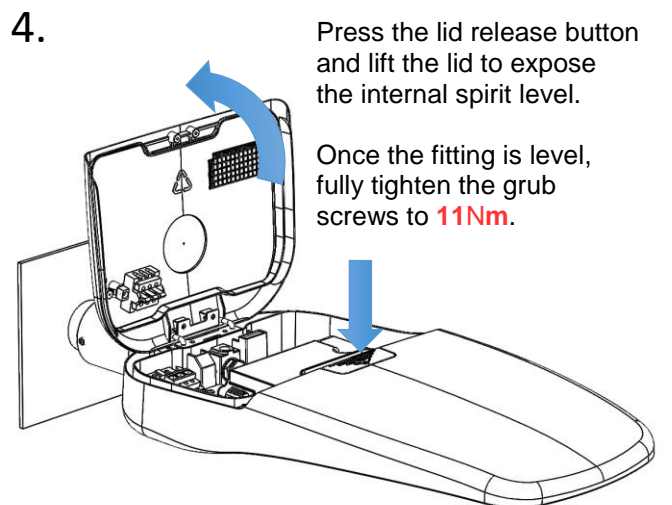

4. Press the lid release button and lift the lid to expose the internal spirit level.

Once the fitting is level, fully tighten the grub screws to **11Nm**.

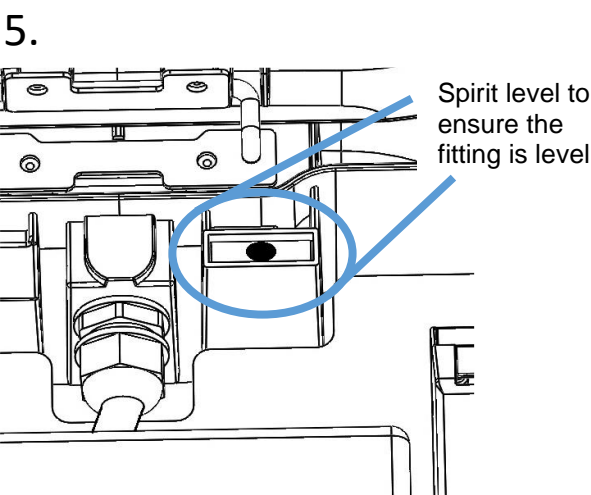

Spirit level to ensure the fitting is level

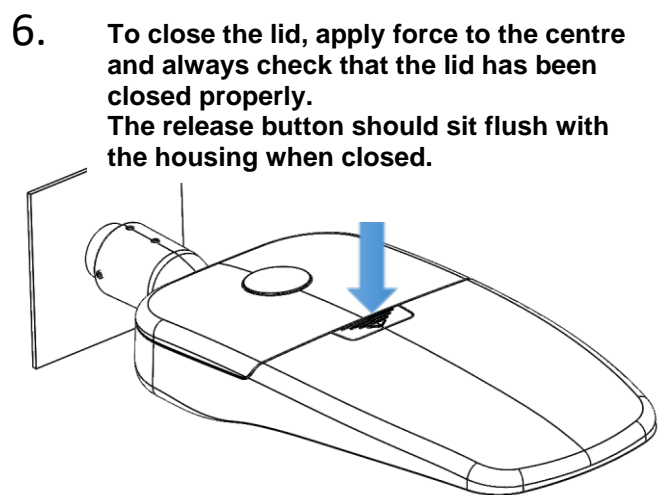

6. To close the lid, apply force to the centre and always check that the lid has been closed properly.

The release button should sit flush with the housing when closed.

Opus Column Installation

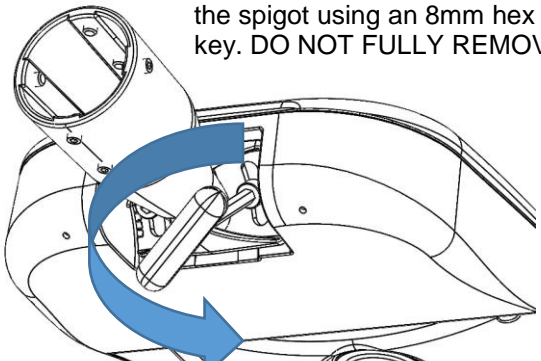
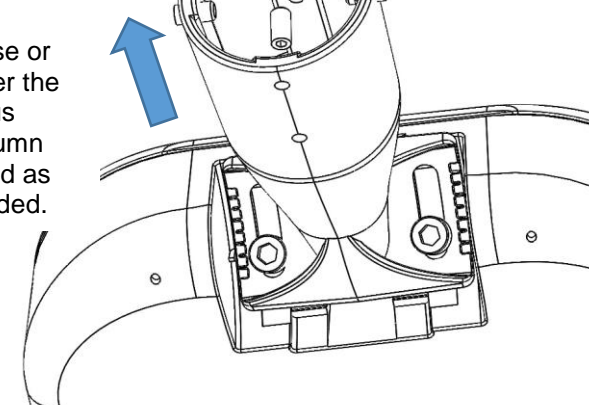
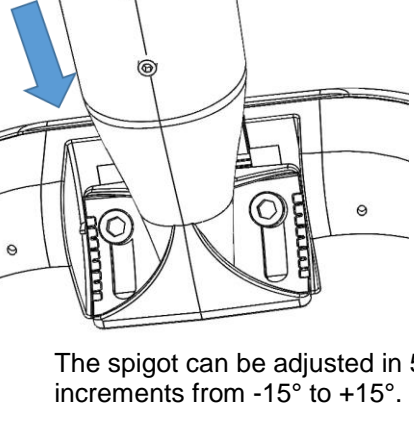
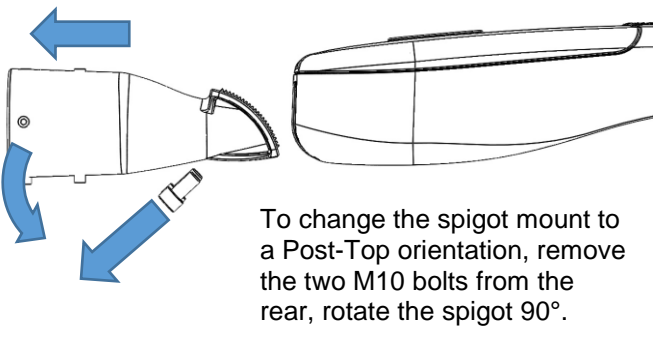
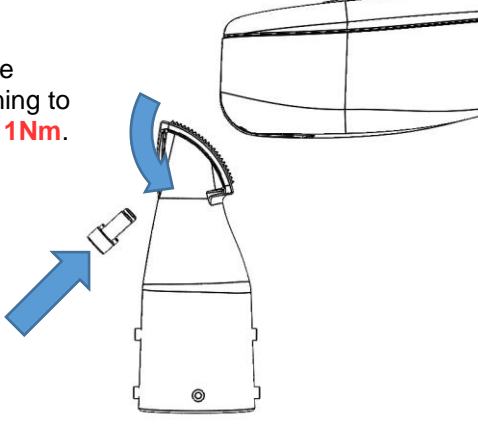
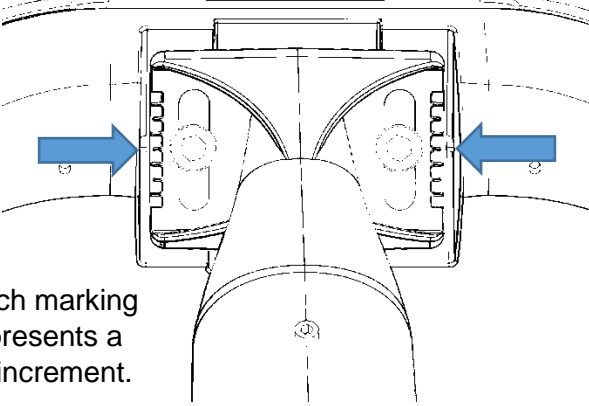
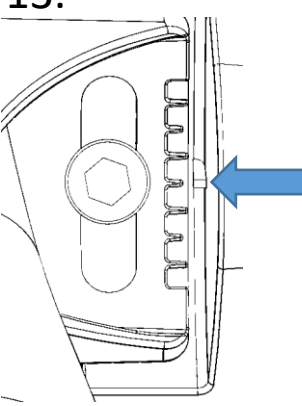
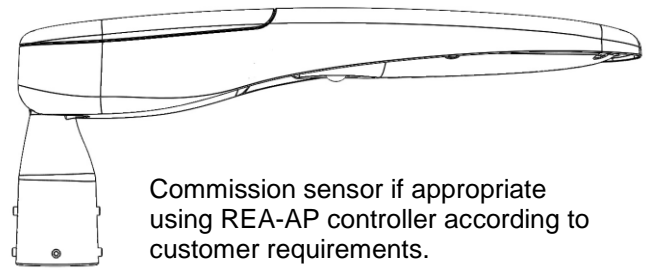
<p>7.</p> <p>To adjust the vertical mounting angle, loosen the M10 bolts on the spigot using an 8mm hex key. DO NOT FULLY REMOVE.</p> 	<p>8.</p> <p>Raise or lower the Opus Column Head as needed.</p> 
<p>9.</p>  <p>The spigot can be adjusted in 5° increments from -15° to +15°.</p>	<p>10.</p>  <p>To change the spigot mount to a Post-Top orientation, remove the two M10 bolts from the rear, rotate the spigot 90°.</p>
<p>11.</p> <p>Re-attach the bolts, tightening to a torque of 11Nm.</p> 	<p>12.</p>  <p>Each marking represents a 5° increment.</p>
<p>13.</p>  <p>When 0° or neutral orientation of the luminaire (with both vertical and horizontal spigot positioning) is required, the central mark on the spigot must align with the mark on the body. DO NOT use any part of the body to reference from.</p>	<p>14.</p> <p>Follow steps 1-8 to install on a Column.</p>  <p>Commission sensor if appropriate using REA-AP controller according to customer requirements.</p>

Opus Column Installation

Maintenance

- 1 Disconnect luminaire before undertaking any maintenance or cleaning.
- 2 Cleaning should be undertaken on external parts of the luminaire only using a slightly damp lint free cloth.
- 3 To open lid push down on centre to release the lid and access gear tray.
- 4 Gear tray and components are removable by using a pan pozi screwdriver.
- 5 To access LED circuit use an allen key to remove diffuser then use a pan pozi screwdriver to remove lens.
- 6 Please contact Dextra for assistance with spare component supply.

